

Dual Wall Pro Earth User Manual



A Complete Guide From Installation To Operation



EVA-07D-SE-W / EVA-22D-SE-W
EVA-07D-SE-W-C / EVA-22D-SE-W-C

Dual Outlet Wall AC Charger
User Manual

Disclaimer

Dual Wall Pro Earth



Disclaimer

This user manual is copyrighted by Project EV. (Hereinafter referred to as “ATESS Power Technology”). No company or person may extract or copy part or all of this user manual without the written permission of ATESS Power Technology. Content must not be transmitted in any form, including materials and publications.

All rights reserved. ATESS Power Technology has the final right to interpret this user manual. The information in this manual is subject to change without notice.

Thank you for using Project EV charging equipment!

EVA series of intelligent dual outlet AC charger is a power supply device that uses professional and advanced technology to provide energy supply to electric vehicles, it also has friendly man-machine interface and versatile functions of control, billing, and communication. The charger can be connected to a back-office server to utilise the functions of diversified communication options, including wired Ethernet, WIFI, 4G is available for back-office server connection. We sincerely hope that this product can meet your needs and will continuously improve the quality of our products.

Product Features

Dual Wall Pro Earth



Features Packed as Standard



We pack our products with the best features, so you can make the most out of your EV charger.

All of our 7.3kW fast charge points, up to our 40kW rapid chargers, are all OZEV approved. All of our chargers are OCPP 1.6 compliant, all meeting UK & European standards, and they are all covered by a market leading five-year warranty.



Project EV are proud to be one of the most competitively priced electric vehicle charge point manufacturers on the market, with a highly versatile range, we are positive Project EV can solve all your charging needs.

Key Features



Compact Design

Attractive appearance, simple but elegant



Full Protection

Full electrical protection, over/under temperature protection, etc



Global Standard

OCPP v1.6 open charge point protocol. IEC 62196 type II connector



Intelligent

Intelligent power adjustment, emergency stop, WiFi/APP/ethernet monitoring



Contents

Dual Wall Pro Earth



-	Disclaimer	1
-	Product Features	2
-	Product Description	4
-	Specification	5-6
	EVD-07D-SE-W	
	EVD-22D-SE-W	
-	Packaging List	7
-	Installation	8
	Wall Mounted	
	Pole Mounted	
-	CT Clamp	12
-	Load Management	13
-	Configuring a laptop for commissioning	14-15
-	Laptop Commissioning settings explained	16-18
-	Project EV Standard App	
	Using the App	
	Creating a new account	
	Commissioning Process	
	EV Smart Charge Point Regulations	
	App Status	
	Charger Control Methods	
	Scheduling a charge	
	Making your unit bespoke	
	Account Management	
-	Troubleshooting	35-37
-	Further Support	38
-	Warranty	39-42
-	FAQ's	43-44
-	Social Media	45

Product Description

Dual Wall Pro Earth



1. LOGO
2. LCD display
3. Screen Selection
4. RFID reader
5. A/B status indicator
6. Emergency Stop Button
7. Socket Outlet
8. WIFI/4G Antenna
9. Cable Entry
10. Mounting Bracket

Specification

EVA-07D-SE-W / EVA-07D-SE-W-C



Input & Output

Input Amps	63a Single Phase
Input voltage	230V AC
Input frequency	50HZ
Output voltage	230V AC
Max. output power	7KW per socket
Max. output current	32A per socket
Charging interface type	IEC 62196-2, Type 2

Protection

Over voltage protection	✓
Under voltage protection	✓
Over load protection	✓
Short circuit protection	✓
Earth leakage protection	✓
Over-temp protection	✓
Surge protection	✓
Anti-Tamper Switch	EVA-07D-SE-W-C Model Only

Function & Accessory

LCD	Yes
Ethernet/WIFI/4G	Yes/Yes/Opt.
Outlet Type	Type 2 (socket)
Number of outlets	2
RCBO	Type A +6mA DC fault current protection (Equivalent to Type B)
LED Indicator light	✓
Emergency stop button	✓
Mid Meter	✓
RFID	✓
Dynamic Load Management	Modbus Meter only (EV-SPM)

Working Environment

Protection degree	IP65
Environment temperature	-25°C~+50°C
Relative humidity	0-95% non-condensing
Cooling	Natural air cooling
Standby power consumption	<8W
IK Rating	IK10

Mechanical

Dimension (W/H/D)	360/562/176mm
Weight	16KG

Mounting & Accessories

Wall-mounting	Standard
Floor-pole	Opt. EV-SEW-FLRSTAND
Ground-mounting	Opt. EV-GMEVA-D-2

Certification

CE	✓
SA8000 Accredited	✓
OZEV Approved	✓
UKCA	✓

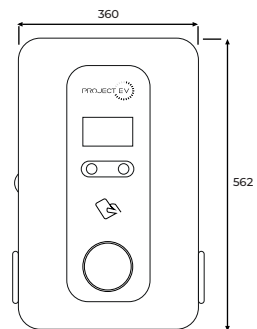
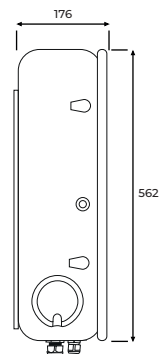
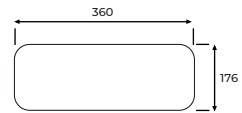

Specification

EVA-22D-SE-W / EVA-22D-SE-W-C

Input & Output

Input Amps	63a Three Phase
Input voltage	415V AC
Input frequency	50HZ
Output voltage	415V AC
Max. output power	22KW per socket
Max. output current	32A per socket
Charging interface type	IEC 62196-2, Type 2

Protection

Over voltage protection	✓
Under voltage protection	✓
Over load protection	✓
Short circuit protection	✓
Earth leakage protection	✓
Over-temp protection	✓
Surge protection	✓
PEN fault protection	✓
Anti Tamper Switch	EVA-22D-SE-W-C Model Only

Function & Accessory

LCD	Yes
Ethernet/WIFI/4G	Yes/Yes/Opt.
Outlet Type	Type 2 (socket)
Number of outlets	2
RCBO	Type A +6mA DC fault current protection (Equivalent to Type B)
LED Indicator light	✓
Emergency stop button	✓
Mid Meter	✓
RFID	✓
Dynamic Load Management	Modbus Meter only (EV-TPM)

Working Environment

Protection degree	IP65
Environment temperature	-25°C--+50°C
Relative humidity	0-95% non-condensing
Cooling	Natural air cooling
Standby power consumption	<8W
IK Rating	IK10

Mechanical

Dimension (W/H/D)	360/562/176mm
Weight	16KG

Mounting & Accessories

Wall-mounting	Standard
Floor-pole	Opt. EV-SEW-FLRSTAND
Ground-mounting	Opt. EV-GMEVA-D-2

Certification

CE	✓
SA8000 Accredited	✓
OZEV Approved	✓
UKCA	✓

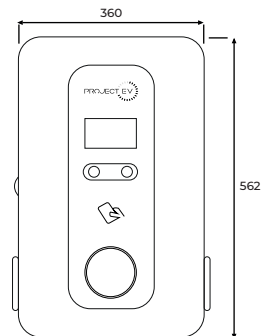
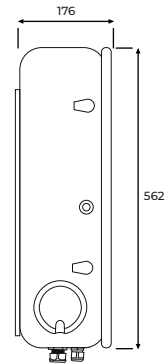
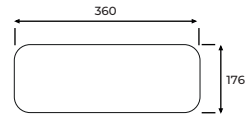

Packaging List

Dual Wall Pro Earth

No.	Name	Qty	Remark
1	Charger	1	
2	User Manual	1	
3	Quality Certificate	1	
4	User Card	3	
5	ST6.3 x 40 Stainless steels hex-head self-drilling screws	5	Fixed Bracket
6	12 x 46 Plastic expansion plugs	5	Fixed Charger
7	M6*16 Stainless steels hex-head self-drilling screws	2	Charger fixation

Installation

Wall Mounted

Mount on a Wall

1. Open the packaging, you'll see a charge point, a mounting bracket, a user manual and a bag of mounting accessories. There is also an RFID card.

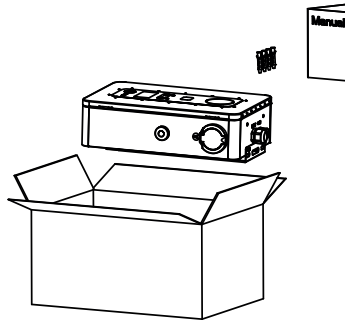

2. Remove the mounting bracket from the charge point, use it as a template to mark the position of the 10mm drill holes. Drill the holes and hammer the expansion bolts in the accessories bag into the holes. Then use the fixings provided to fit bracket to wall.

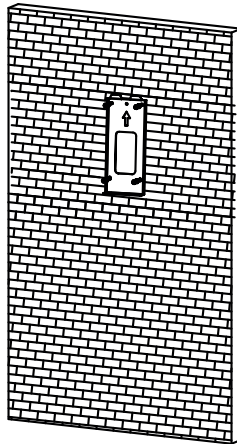

Installation

Wall Mounted

3. Mount the charge point onto the bracket, and fix it with the 2 screws at the bottom of a charge point. This will secure the charger to the bracket.

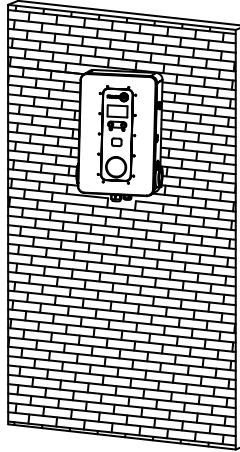

4. Using the keys provided, open the door to the charger, crimp the cables using M8-x Metal crimp lugs. Polarity can be found written on the terminal points - the RCBO is at the top of the unit (Left is A and Right is B) and may need the resetting to power up. Once complete, close and lock the access door of the charger.

7kw

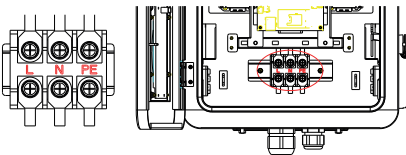

	Model	L	N	PE
Terminal	7K			
Wire	7K	≥16m ² ≥AWG5	≥16m ² ≥AWG5	≥16m ² ≥AWG5

22kw

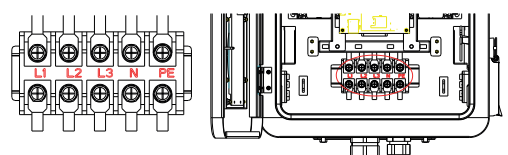

	Model	L1	L2	L3	N	PE
Terminal	22K					
Wire	22K	≥16m ² ≥AWG5	≥16m ² ≥AWG5	≥16m ² ≥AWG5	≥16m ² ≥AWG5	≥16m ² ≥AWG5

Installation

Pole Mounted

Mount on a Pole

1. Open the packaging of the pole, take out the pole and mounting accessories.

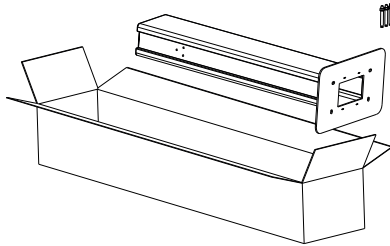

2. The pole must be installed on a hard surface (concrete surface is recommended or ground mount for soft ground). It can also be mounted on a solid ground. Drill holes according to the requirements marked on the illustration for fixing expansion bolts.

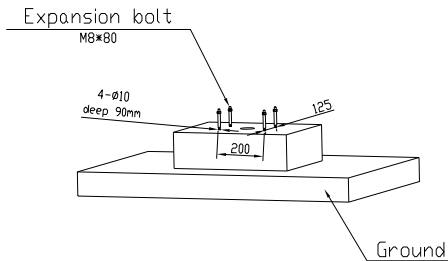

3. Fix the pole onto the holes with expansion bolts. The input cables go into the pole from the centre at the bottom and will exit through the grommit provided below the charger.

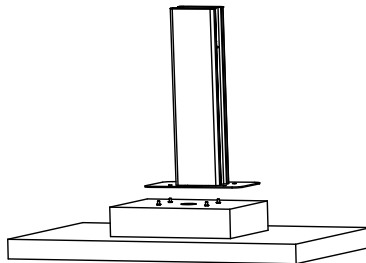

Installation

Pole Mounted

4. Position the charge point on top of the mounting pole and secure with 4 screws, 2 from the box of the mounting pole and 2 from the charger (originally holding the wall bracket to the charger). This will secure the charger to the post and the wall mounting bracket is no longer needed.

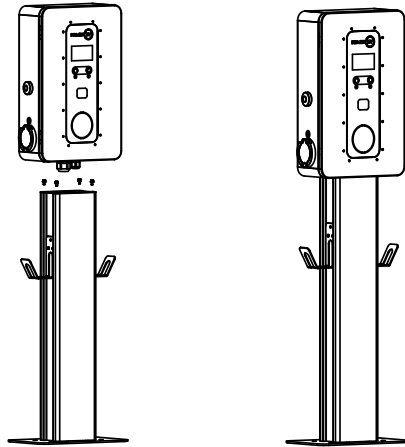

5. Using the keys provided, open the door to the charger, crimp the cables using M8-x Metal crimp lugs. Polarity can be found written on the terminal points - the RCBO is at the top of the unit (Left is A and Right is B) and may need the resetting to power up. Once complete, close and lock the access door of the charger.

7kw

22kw

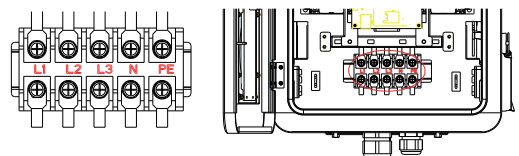
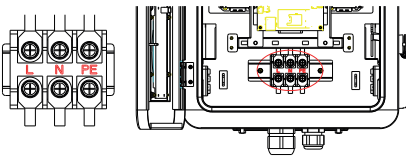

	Model	L	N	PE
Terminal	7K			
Wire	7K	$\geq 16\text{m}^2$ $\geq \text{AWGS}$	$\geq 16\text{m}^2$ $\geq \text{AWGS}$	$\geq 16\text{m}^2$ $\geq \text{AWGS}$

	Model	L1	L2	L3	N	PE
Terminal	22K					
Wire	22K	$\geq 16\text{m}^2$ $\geq \text{AWGS}$	$\geq 16\text{m}^2$ $\geq \text{AWGS}$	$\geq 16\text{m}^2$ $\geq \text{AWGS}$	$\geq 16\text{m}^2$ $\geq \text{AWGS}$	$\geq 16\text{m}^2$ $\geq \text{AWGS}$

Installation

Modbus Meter

To monitor the real-time power import and export, a CT clamp is needed for this function to work properly. The CT Clamp is needed to operate and use, both solar and dynamic load balancing only.

Note: CT Clamp wiring can be extended up to 50m using Cat5e cable.

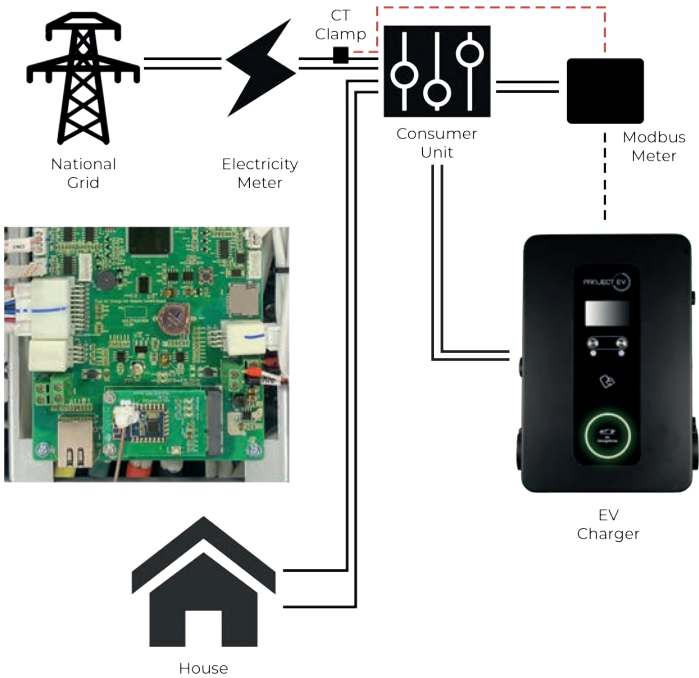

Load Management

Dual Wall Pro Earth

Dynamic Load Management

For dynamic load management to work the Modbus Meter must be installed correctly and the following setting must be set:

- **Enable Power Allocation - Enabled**
- **External current sampling method - Meter**
- **External monitored max input power (kw) - main fuse size**
- **Meter Address - Side Of Meter**

External monitored max input power is measured in kw and must be set to the main fuse size so that if the load on the property was to reach the limit set the charger would reduce it's output accordingly to not exceed the property main fuse.

60A = 13kw
80A = 18kw
100A = 23kw

Static Load Management

For installations where dynamic load management is not possible you can hard limit the charger using setting '**charger maximum output current (A)**' - As default this will be 32A, however can be downrated to as low as 6A (1.76kw) if required and anything inbetween.

Configuring a laptop for commissioning

Setting the laptop for a static IP.

The Charger's default IP address is 192.168.1.5. To access the parameter setting interface, you'll need to first set the computer's IP to **192.168.1.3**

To set a static IP on your Windows computer:

1. Click **Start Menu > Control Panel > Network and Sharing Center**. (For Windows 8 and higher, search for and open Control Panel and select Network and Internet).
2. **Click Change adapter settings.**

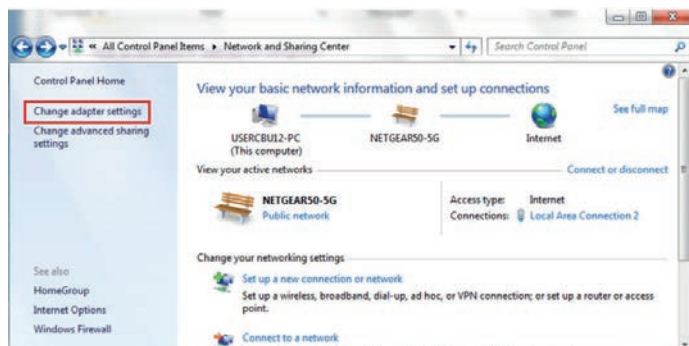

3. Right-click on Local Area Connection Ethernet and click on properties.

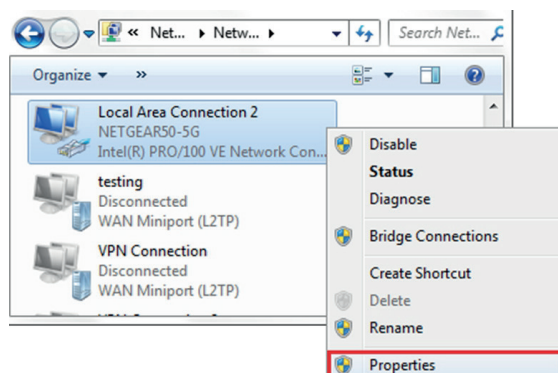

Configuring a laptop for commissioning

4. Select Internet Protocol Version 4 (TCP/IPV4) and click on properties.

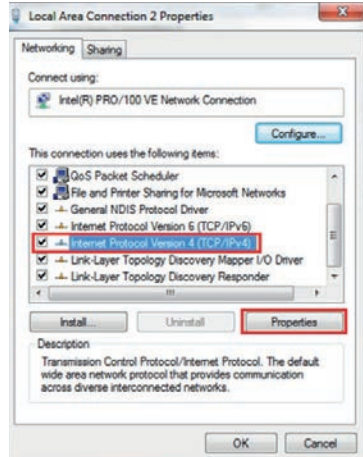

5. Select 'Use the following IP address' and enter the IP address, subnet mask, default gateway. Click OK and close the Local Area Connection properties window.

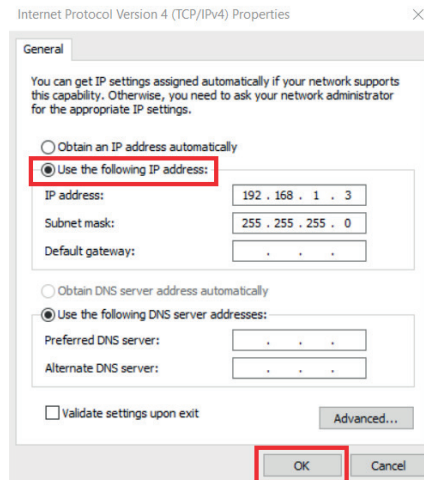

Laptop commissioning settings explained

Connect the charger to a computer via a network cable. Open the web browser and type in **192.168.1.5:8080** in the address field and click enter, then the parameter setting page of the charger will open up.

Parameter setting can only be done via web browser on a computer. It is suggested to use microsoft edge or chrome (other browser might have compatibility problems).

Lithopic Charger Parameters

1	Firmware Version Num:	FW:019.00 ver 2.9.2020065_Norm8
2	Charge ID(MaxLen 20):	EP04000E73
3	Charger IP:	192.168.1.1
4	Subnet Mask:	255.255.255.0
5	Net MAC Address:	30.80.30.F8.3F.1E
6	DHCP Enable(0-STATIC,1-DHCP):	0
7	Authentication Key(MaxLen 20):	12345678
8	WiFi SSID(MaxLen 30,Not support '?'):	litho_charger
9	Server URL(MaxLen 250):	http://openlithocharger.com/8080open
10	Charger Time(VV-HH-DD HH-MM-SS):	2020-09-11 21:26:49
11	Time Zone:	VTC+1.00
12	Max Temperature(Max 85):	85
13	MeterValue Interval(0-300 Sec):	60
14	HG Account(MaxLen 30):	
15	HG APN:	08.1304.net
16	Login Password:	
17	Type B RCD(Enter 0 Calibration):	0.00s
18	Solar Mode Charge(0-Disable,1-ECO,2-ECO+):	0
19	Power Distribution Charge(0-Disable,1-Enable):	0
20	External Machine Power:	0W
21	PowerMeter Type:	160W/200V/10A
22	Off Peak Charge(0-Disable,1-Enable):	1
23	Off Peak Time1(MM-HH-mm-SS):	00:00-07:30
24	Off Peak Time2:	11:00-13:30
25	Off Peak Time3:	22:00-00:00
26	Off Peak Time4:	00:00-00:00
27	Off Peak Time5:	00:00-00:00
28	Stand Delay Charge Time(Sec):	600
29	(Save and Reset)	
30	Language Set:	English
31	Machine Type:	EV-075.50
32	Default Gateway:	192.168.1.1
33	Charger DNS:	8.8.8.8
34	Max Output Current Set(6-32A):	30.0
35	Charge Mode(Default 1-APP,2-WFID,3-Plug&Charge):	3
36	Card Pin(6 digits, E.g:123456):	14200?
37	WiFi Key(MaxLen 64,Not support '?'):	
38	Charging Rate (Per kWh):	0.18
39	Daylight Saving Time(MM-DD):	03-27-19-30
40	Auto Charging Time(Plug&Charge):	00:00-00:00
41	Heartbeat Interval(0-3600 Sec):	60
42	HG Password(MaxLen 30):	
43	Wait For Plug Gun Time(Sec):	60
44	Type B RCD Protection Level:	1
45	Grid Limit Charging Current(Solar Mode 0-63A):	6
46	External Power Sampling Wiring:	CT2000.1
47	Off Peak Charge For Meter(Plug&Charge, 0-Disable,1-Enable):	1
48	PowerMeter Addr:	0
49	Off Peak Current1(A):	0
50	Off Peak Current2:	0
51	Off Peak Current3:	0
52	Off Peak Current4:	0
53	Off Peak Current5:	0

Laptop commissioning settings explained



1. Firmware version of the Charger. This item cannot be modified here on the setting page.
2. Charger ID: this is the unique identification of the Charger. If the charger is to be connected to Project EV back-office server, this ID must be set as the serial number on the nameplate of the Charger. Otherwise the Charger cannot be registered on the server.
3. Charger IP: The default IP is 192.168.1.5. It is not suggested to change the default IP. If you have changed the default IP and forgot the new IP, you can reset the charger to factory setting by long press the reset button(the reset button on control board, not the emergency stop button) until the charger reboot. Then you can use the default 192.168.1.5 for access. Please note: ID(same as serial number, can be found on the nameplate sticker) and server url, otherwise the charger won't be connected to the back-office server. After restoring the charger to factory setting, you'll need to reset the charger
4. Charger Subnet mask: The default value is 255.255.255.0. It is not suggested to change. If the subnet mask has been reset to other value and you have forgotten the new value, you can restore the charger to factory setting by long press the reset button.
5. Net MAC Address
6. Change the charger from static IP to DHCP- It is recommended to use static to allow future access if required.
7. RFID TAG Limit
8. WiFi SSID(wireless network name)
9. Server URL is to set the domain name or IP address of the back office server to be connected. The domain name of Project EV is **<ws://projectevcharger.com:80/ocpp/ws>**. For electric miles use **<ws://ocpp.electricmiles.io>**
10. Charger Internal Time - This is when the unit is online as the time is retrieved from the server.
11. To be used to alter the time zones should the charger be installed outside GMT time zone.
12. Max Temperature the charger internals will reach before triggering a fault.
13. Meter value time in Seconds - The charger sends these to the server to be displayed in the app.

Laptop commissioning settings explained

14. Only Required with other brands of sim cards
15. If used in 4G this is required to let the charger know which sim server to connect to.
16. This is the login password for the or laptop on commissioning default is 12345678 and is recommended to change this on commissioning.
17. RCD Calibration
18. Solar Modes
19. Enable Load Management / Solar Features
20. Property Main Fuse Size (kw)
21. Load Management Meter Model
22. Opt Out/ Opt In of the UK EVC regulations default charging hours plug + charge
- 23-27. UK EVC regulations 2021 charge allowed times
28. UK EVC regulations 2021 randomised delay to 600 secs and can be changed by end user
29. Save settings
30. Language
31. Charger Module
32. LAN Connection default gateway
33. Charger DNS server
34. Static output of the charger
35. Charging Mode: 1. APP/RFID mode; 2. RFID Mode; 3. Plug & Charge Mode
36. RFID Default Pin
37. WIFI Password
38. Default charging cost for records for multi tariffs set up in the app.
39. Daylight saving start + end date
40. Plug + charge allowed charge window
41. Heartbeat signal sent to the server (time in seconds)
42. Password required by some sim cards that are not Project EV.
43. Time out (in seconds) for starting charge without plugging in a vehicle
44. Required for testing purposes only
45. Minimum export power required before the vehicle charge will engage (1.76kw/6amp)
46. Load Management reading hardware - CT/Power Meter
47. Opt Out / Opt In of the UK EVC regulations default charging hours plug and charge
48. Power Meter Address
- 49-53. Limit your charger to the adjacent times. 0 is default setting 34.

Project EV Standard App

Using the App



Introduction to the Project EV Standard App

Description

The Project EV Standard App is an app for controlling your charger. It can help you quickly and easily charge your vehicle with your charger.

Main Functions Of Project EV Standard App

- (1) The user can add a charger by entering the chargepoint serial number and scanning the QR code.
- (2) The user can control the start and stop of the charger through the APP.
- (3) The user can preset the charging scheme and reserve charging.
- (4) The user can modify the parameter settings of the charger.
- (5) Users can authorise other users to use their own charger.
- (6) The user can view the charging record.
- (7) Users can manage and set up their own accounts.

Performance

The APP is easy to use and reliable, it guarantees information security and confidentiality.

Instructions

APP download and install

Android phone users can search and install "Project EV" through Google play.
iPhone users can search and install "Project EV" through the App Store.

Registration and login

When the user first visits, the user registration is performed by the following steps:
Click the desktop icon Login page Register.

Project EV Standard App

Creating a new account



Firstly, if you have not done so already, you will need to create a unique account for yourself. Select **register** on the top right of the app and follow the required fields. These are de-noted with a * next to them. If an installer details are unknown, please state **unknown** as they are a required field. Once all the fields have been completed, read and tick the user agreement before pressing register.

Installer details are used by Project EV to give assistance to installers, and to contact them should an issue be raised. This could be installation based and not charger hardware issues.

Installer Top Tip:

If you are installing Project EV chargers regularly, set your own account up to commission the chargers - when completed simply delete the charger from your app and add to the customer account - All the settings entered are transferred over!

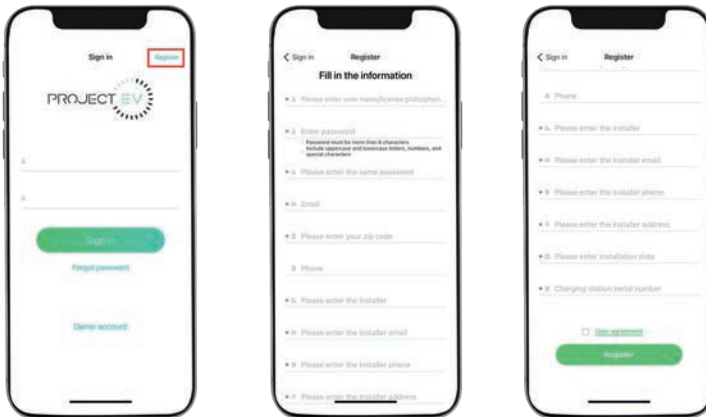

Project EV Standard App Commissioning Process



APP Commission

1. Download Project EV App.
2. Create user account
3. Add charger to serial number on the account.
4. Power charger up from the fuseboard – (This will emit hotspot for 1-2 minutes from when unit is powered on to allow user to get back to charger)
5. Press the WiFi symbol in top right of the App
 - a. Go to WLAN settings
 - b. Connect to charger Serial Number
 - c. Enter password **'12345678'**
 - d. Go back into the App
 - e. Serial Number appears above connected next
 - f. Press **'Connected Next'**
6. Enter in the desired settings. (CAUTION: Any WIFI details are case sensitive).

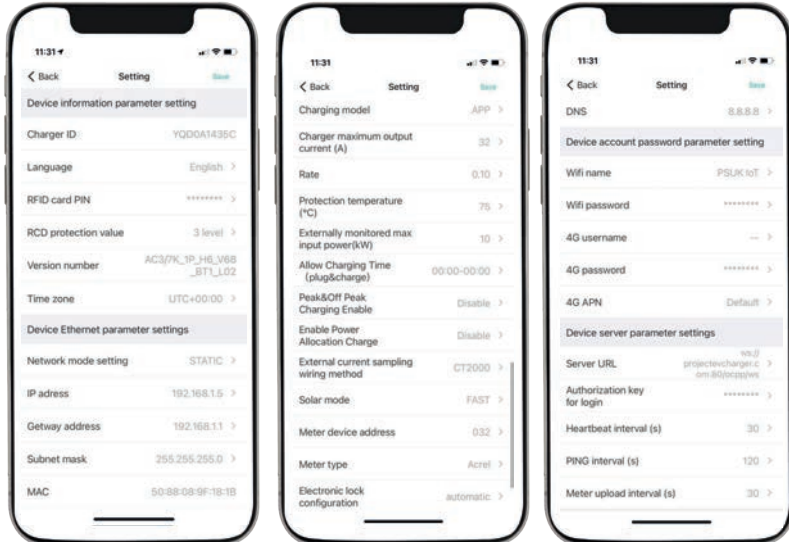

EV Smart Charge Points Regulations

What are the EV Smart Charge Points Regulations?

The Electric Vehicles (Smart Charge Points) Regulations 2021 is the sale and installation of electric vehicle charge points are prohibited unless they meet smart functionality requirements.

The regulations only affect charge points defined as:

- Occupiers of domestic premises and their visitors
- People at their place of work including fleet drivers at most depots

At Project EV, we would like to highlight and put your mind at ease that all of our charge points comply with these new standards and have been designed to protect both the stability of the electricity grid and our consumers. Project EV is working in partnership with Electric Miles to provide consumers with not only a compliant solution, but the best smart charging experience available.

Key Points You Should Know

- **Default off-peak charging** – The charge point will not operate during peak hours of 8am to 11am and 4pm to 10pm, on weekdays. We would like to make it clear that you can override these options if you wish.
- **Demand Side Response (DSR)** – Any charge point with a DSR Agreement won't need to follow the default off peak charging regulations as a DSR Agreement will work in conjunction with the end user's electricity tariff enabling the user to save money. Project EV has teamed up with **Electric Miles** who can provide this feature should you require it.
- **Randomised delay** – Please note when you set your car to charge it may not start instantaneously, it may take up to 600 seconds before the car begins to charge. This is of no fault on the charger, it is simply complying to regulation above. However, there are certain charging scenarios where this functionality is not desirable, particularly if an immediate response is needed from the charge point, therefore the owner or end-user has the option to cancel the randomised delay by manually overriding the delay for that charge.

If you have any questions regarding the regulations above please send an email to: enquiries@projectev.co.uk

These regulations are mandatory, and will come straight out the box with the settings included. As per regulations, in certain circumstances, these regulations are not desirable and must give the end user the option to opt out at any point - as well as to opt back in.

EV Smart Charge Points Regulations

How to opt out of the peak charging hours

To opt out, there are two ways to do this. The first way is to plug into the unit with a laptop and change setting 22 + 47 to 0. This will disable the pause in charging in peak hours. The second way is once the unit is available on the app, go into the settings, into EV smart regulations and select the slider to the left.

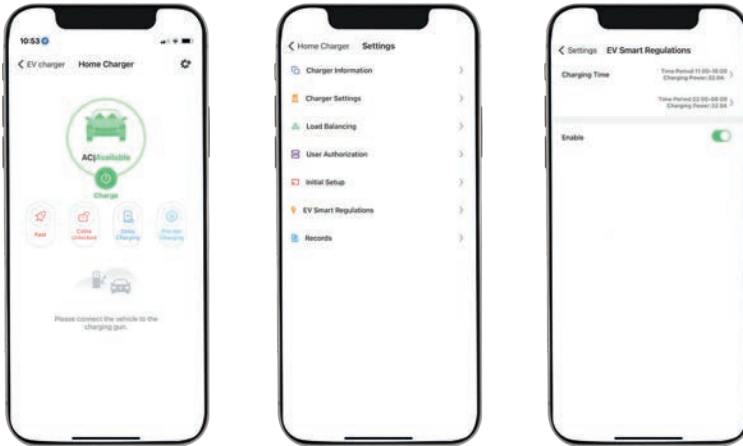

Anti-Tamper Switch

New Regulations require an added level of security, so now units have an anti-tamper switch.

If someone opens the door and activates the anti-tamper switch, the unit displays 14 red flashes and displays error and door open on the app.

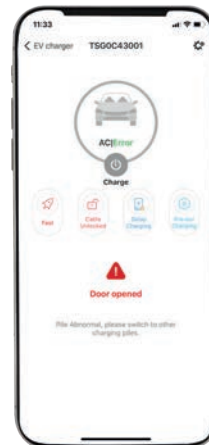

EV Smart Charge Points Regulations

How to opt out / adjust time delay

You can opt out/adjust the time delay on setting 28 when configuring with a laptop. However, similar to the peak hours settings, this can also be done via the app.

Firstly, select delay charging on the home screen to access the settings. The slider to the left will turn off all time delays. There are two options if you wish to keep the time delay - default will operate and start the charge any time from 0-600 seconds whereas custom will start the charge after the set period of 1-1800 depending on the desired range.

Should you start a charge with the time delay enabled you can start the charge immediately by pressing the charge button again. Otherwise the charge will begin automatically once the time delay has been passed.

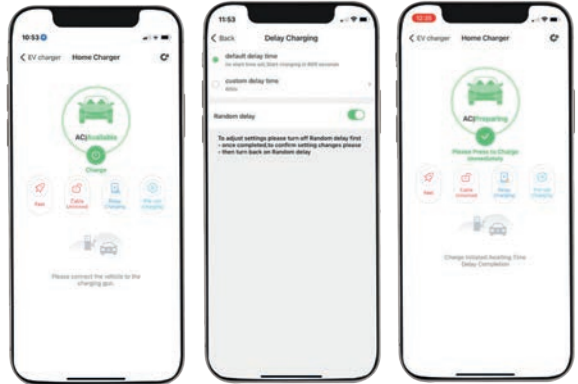

- **Privacy** - Charge points are now required to meet certain privacy and security standards. In terms of privacy, chargers ensure all data sent to and from the station is encrypted and protected to safeguard user privacy and mitigate the risk from cyber attacks. The regulations also require users to be able to easily control what data they share and provide ways of deleting any personal data that has been collected. By default, this information will only be retained for 12 months.

- **Security** - New regulations require an added level of security. The regulations require that a charger must be 'designed, manufactured and configured to provide appropriate protection against the risk of harm to, or disruption of, the electricity system and the relevant charge point.' In other words, chargers will need to ensure they are created in a way that safeguards the user's safety, prevents damages to the charger, and guarantees the charger won't disrupt the electrical grid, for example, by overloading it.

These regulations are mandatory and will come straight out the box with the settings included. As per regulations, in certain circumstances, these regulations are not desirable and must give the end user the option to opt out at any point - as well as to opt back in.

If you have any questions regarding the regulations above please send an email to: enquiries@projectev.co.uk

Project EV Standard App

App Status

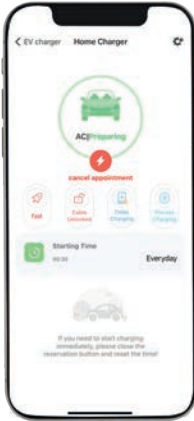

Schedule Charge Set

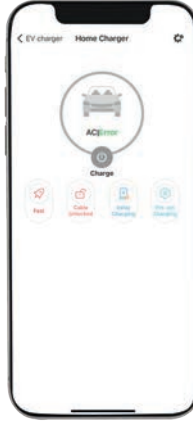

Charger Faulted

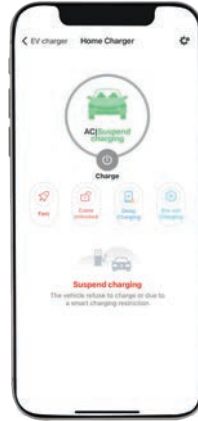

Car Fully Charged



Car Plugged In



Charger Offline



Car Charging

Project EV Standard App

Charger Control Methods



Charging Mode & Operation

APP/RFID Mode:

Initiate or cease charging by using App or by swiping RFID card (If applicable). You can also use App for reservation and payment provided that the back office server supports such functions.

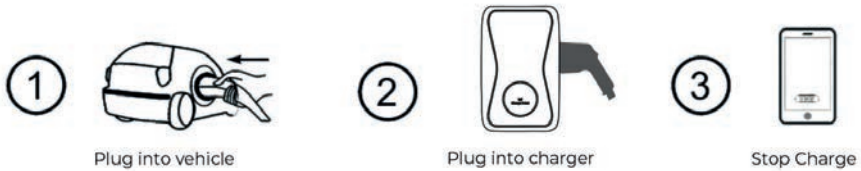

If you are using the Project EV App, charging can be stopped by pressing the on/off button on the App.

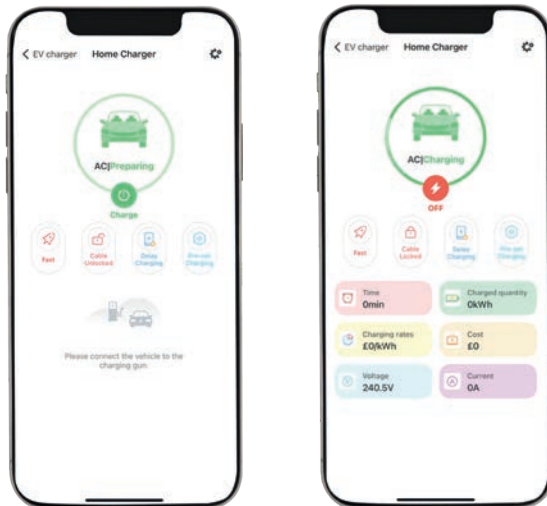

Always ensure you plug charger in vehicle, then charger before using App or RFID.

Project EV Standard App

Charger Control Methods



RFID Mode:

Always plug in vehicle then charger- then tap RFID

Charging can only be initiated or ceased by swiping RFID card.

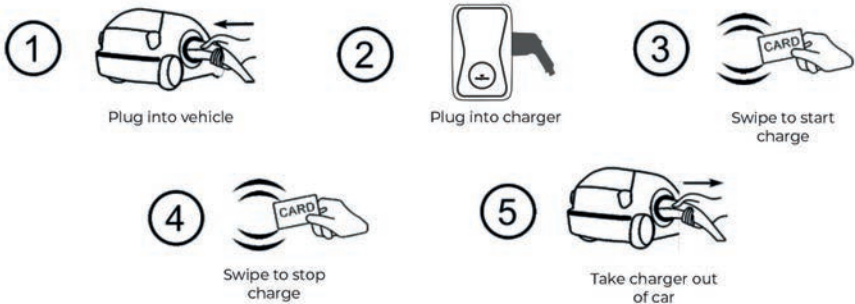

Plug & Charge:

Charging will start automatically after EV plugged in. If you want to stop the charging , just press the forced on/off button on the side of the charger.

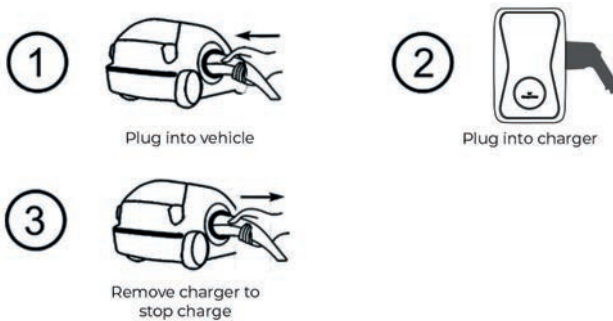

Project EV Standard App

Scheduling a charge

When the chargepoint status is preparing, the user can use the preset charging scheme and the reserved charging function by selecting Pre-Set charging.

When charging, the preset charging scheme, the amount of charge, the amount of consumption, the duration of charging, the charging rate, and the current voltage are displayed.

Preset charging scheme and reservation function



You can make an appointment to charge according to the amount, amount of electricity, and duration. For example, if the preset power is 20kwh, the charge point will automatically stop charging when the charging power reaches 20kwh.

Only one of the three charging schemes can be selected to take effect at 1 time:

Click the cost to set the preset amount. When the preset amount is reached, the charger stops charging.

Click the energy to set the preset power. When the preset power is reached, the charger stops charging.

Click the time to set the preset time. When the preset duration is reached, the charger stops charging.

Project EV Standard App

Scheduling a charge

You can also schedule a charge start time and set whether it will take effect every day. For example, if you want to start charging at 00:30 every day, if the vehicle is connected to the chargepoint, charging will start automatically.

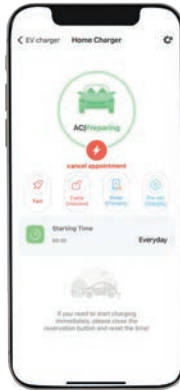

The preset charging scheme and the reservation function can be used simultaneously. However, when using at the same time, the lower reservation charging is only used as the start time, and the reservation time period cannot be set.

Project EV Standard App

Making your unit bespoke



On the setting page, the user can view the charging station ID, and the version number (not modifiable) in charger information:



Parameter settings

You can set the charger parameters by parameter setting.

The basic parameters can be modified - the name of the charger, the national city, and the station.

Under charger settings you can change charge rates which will be used to work out total cost in records. The method of control (App, RFID, Plug + Charge) can also be changed here along with the lead lock system + solar modes.

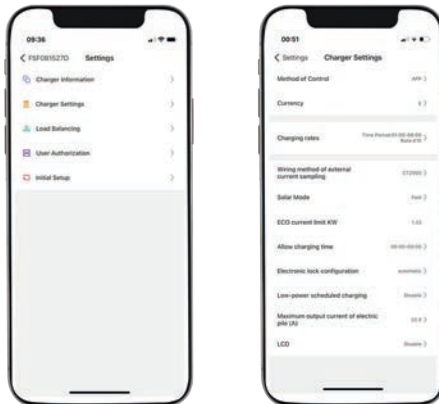

Project EV Standard App

Making your unit bespoke

Charging Record

Press 'Records' found in charger settings to view past charge records, this will include charger ID, Gun A or B, Time, Energy, Cost and many other great details to help you keep track of your EV charging

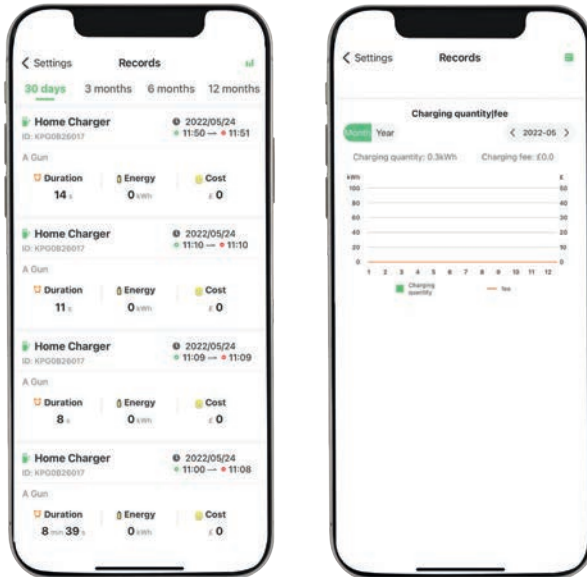

Project EV Standard App

Account Management



Add charger

When you use Project EV for the first time, you need to add the charger in the APP to set up and control it. The process of adding a charger is as follows: Click 'Add' to add a charger by scanning the code or entering the charger ID.

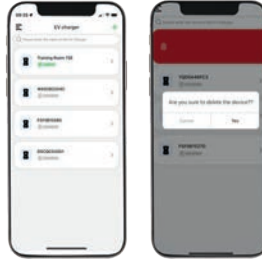

Charger switching and removal

When there are multiple chargepoints, you can switch the chargepoint by clicking on the name of the chargepoint. Press and hold the chargepoint name to remove the chargepoint. You can add a new chargepoint by adding a button.

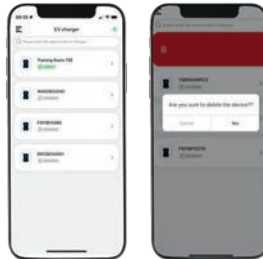

Start and stop control of charger.



Press  to turn on/off.

Note: when charger status is Preparing, you can press  to start charging.

Project EV Standard App

Account Management



Authorisation management

To manage authorised users, you can view the authorisation time, account name, and delete user in the authorisation management interface.



Users can authorise other users to use a charging station through authorisation management. Enter the user name to authorise other users to use the chargepoint.

If the person you want to authorise does not have an account, you can register the new user by pressing the button in the upper right corner of the screen.



Users can manage their accounts, set their avatars, change their passwords, and bind their mobile phone numbers and mailboxes.

Change password: You need to verify the original password, then enter and confirm the new password.

Modify the phone number: Follow the steps to verify the new phone number with a verification code.

Modify the mailbox: Follow the steps to verify the new mailbox by verification code.

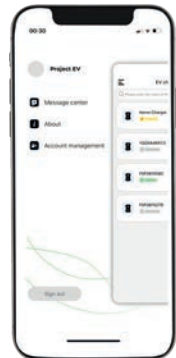

Project EV Standard App

Account Management



Forgotten Password

For a forgotten password, go to the login page, click “forgot password” button, and follow the instructions.

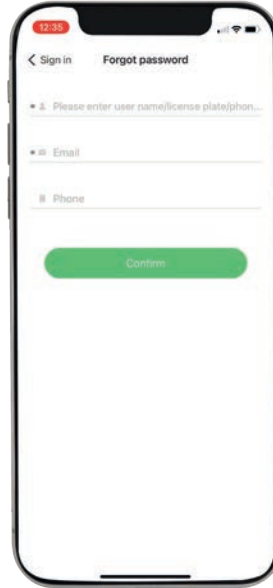
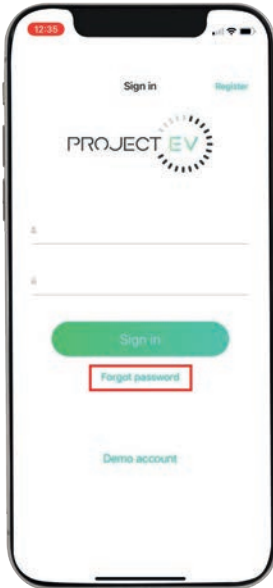

Troubleshooting

Dual Wall Pro Earth

Troubleshoot by LED behaviour or LCD display

If fault occurs, users can check the fault information on the LCD or by the number of blinks of the LED indicator light. Each fault is indicated with a sequence of different numbers of LCD blinking. A pause of 3 seconds between each sequence indicates the beginning or end of a sequence. If multiple faults happen at the same time, each sequence of blinking shows in chronological order at an interval of 3 seconds.

Please see the table below for detailed information:

No.	Fault Code on LCD (If Available)	Number of blinks on the LCD	Fault Description
1	100	3	Red emergency stop button is pressed or broken
2	105	1	Over Voltage on phase L1
3	106	2	Under Voltage on phase L1
4	108	4	Over Current
5	109	5	Over Temperature
6	110	6	DC leakage current detected
7	111	7	RS485 Communication Fault
8	112		Reserved
9	113	9	Type A Switch Fault
10	114	10	Relay
11	115	11	PE Fault
12	116	12	PEN Fault
13	117		Reserved
14	118	14	Anti-Tamper Switch Activated
15	1000		Other Fault

Troubleshooting

Dual Wall Pro Earth

No Connection: App shows unavailable

On the Wi-Fi module (blue band), is there 1 or 2 blue lights?

1 Light:

Check Wi-Fi details entered correctly and Wi-Fi is available at charge point location.

2 Lights-

Check charger is not still connected to phone + check firewall problems.

LED 1-

LED 1 will rapidly flash when the charger is connected to Wi-Fi.

On the 4G module (Red band) is the light solid or flashing?

Solid -

Check Sim is inserted correctly + aerial is correct.

Slow Flashing-

Connected to 3G (Network may take some time to show available. Check 4G APN in charger parameters are correct for the Sim inserted.

Fast Flashing-

Connected to 4G (Check 4G APN in charger parameters are correct for the Sim card inserted.



Troubleshooting

Dual Wall Pro Earth



Charging Issues

If charging cannot start after the car is plugged in

- a. Check if the red emergency stop button is pressed. .
- b. Check what charge mode is being used

APP/RFID- Charge can only be started/stopped by APP or RFID card, and the charger must be connected to the back office server already.

RFID- Charge can only be started/stopped by RFID card.

Plug & Charge- Charge will start automatically when car is plugged in.

c. Check if off-peak charging is set and if charger's time is correct. If off peak charging is set, charge can only start within the charging allowed time period.

d. Check vehicle settings

Cannot unplug the cable from the charging point

When charging finishes, customer can unlock the car with key, and then unplug cable from car and the charging point. If the cable cannot be unplugged from the socket outlet of the charging point, please check if the charging connector is plugged correctly and firmly. If not, please push it to the correct position, then press the silver ON/OFF button on the right-hand side of the charging point to unlock the connector. If it doesn't work, check the settings are set to automatic then disconnect electric vehicle side. If this doesn't work, switch power off to the unit.

Further Support

Project EV



Please use the following details when contacting Project EV so that your query can be pointed to the correct department/people.

Technical Assistance

Option 1:

Send us an email: technical@projectev.co.uk

Send us an email and someone from the team will get back to you via email.

Option 2:

Join us for a **Live Chat**

Go to www.projectev.co.uk during our opening hours, in the bottom right of the page press the 'chat' option. One of the team will join the chat and provide any assistance needed. This would be the quickest way to get in touch.

Option 3:

Give us a call: **0800 599 9582**

Choose options > Project EV (1) > Technical Support (2) In the unlikely event that no one is available to answer immediately, you will be placed into a que for 2 minutes. If the que time is exceeded, the call will be put through to a receptionist who will take a message and someone from technical will get back to you as soon as possible.

Warranty

Dual Wall Pro Earth



5 Year Warranty Statement for ATESS EV AC/DC Chargers

Authorized Warranty Installer

(valid from 1st December 2020)

(These warranty terms are only applicable to UK consumers only for the ATESS EV chargers, bought through the authorized repair and installation partner)

Welcome to Project EV and ATESS, and thanks for choosing our Electric Vehicle charge point.

All our products are backed by a 5-year warranty (3-years parts and labour plus 2 years parts) giving you years of trouble-free charging.

However, in the unfortunate circumstances where something does go wrong, we are here to help and get you up and running as soon as possible.

Electric vehicles are changing all the time and even what appears to be the same manufacturer, model and year can have different battery and software configurations, we understand this can be frustration but sometimes the problem can lie with the vehicle and manufacturer.

With this in mind, we have developed a product that allows our company to make changes remotely and update chargers to keep them running at their optimum and in step with the latest electric vehicles on the road.

All we ask is that you follow the process below and make a number of small checks prior to calling or email the team.

- It sounds obvious but check the emergency stop button has not been activated.
- Check the RCD on the unit.
- Check the consumer unit in the property.
- Check all cables are installed correctly and are not loose or have been damaged.
- Check power cable to the vehicle.
- Check the manufacturers charging guidelines (doors may need to be locked and the vehicle alarmed etc.)
- Make sure the vehicle software is the latest version, please refer to the manufacturer guidelines.
- Please make sure the charger is online – we will not be able to remotely access or diagnose faults if it is not.
- Call 0800 599 9582
- Email enquiries@projectev.co.uk please take pictures or videos

• If we cannot diagnose the fault we will aim to get an engineer to your charge point location to rectify your problem with a replacement or fix the issue (we will not call out to solve or fix Wi-Fi or connectivity problems, please refer to your original installer.

1. Warranted Products

This 5 Year limited warranty shall only apply to EV Chargers AC/DC only installation up to 300kW installed and provided by an Authorized 5 Year Warranty Installer.

2. 5 Year Limited Warranty

A. 5 years Limited Product Warranty

ATESS warrants its EV chargers, known as 'ATESS Products' here after including factory assembled charger sockets, charger plug and cables, if any, to be free from defect in materials and workmanship which would impact the functionality of the product under normal application, installation, use and service conditions. The duration of this limited warranty is for life from the date of delivery in the original packing to the first customer (CUSTOMER) of the ATESS products, or latest 6 months after manufacturing date, the earlier time between the two.

Warranty

Dual Wall Pro Earth



Claims under the warranty can only be accepted if the buyer can provide the proof that the malfunctioning or non-conformity of ATESS Products results exclusively from defects in materials and/or workmanship under normal application, installation, and use and service conditions. If an ATESS Product fails to conform to this warranty, ATESS will, at its option, either repair or replace the product. In the event that a like for like replacement is not available and upgrade may be offered at an additional customer cost

A.1 Product Warranty within / up to 3 years

If, within a period of three (3) years, the costs belonging as below:

Items	Cost Belonging
Spare Parts	ATESS
International Transportation	ATESS
On-site service (If needed)	ATESS
Other Cost	Installer/User

A.2 Product Warranty from 3-5 years

If, within a period of three (3) years, the costs are belonging as below:

Items	Cost Belonging
Spare parts (*except DC chargers)	ATESS
International Transportation	Installer/User
On-site service (If needed)	Installer/User
Other Cost	Installer/User

3. Exclusions and Limitations

The aforementioned "Limited Warranty" does not apply to any ATESS Products which have been subjected to:

- A. If the direct customers who has obtained the ATESS Products from ATESS or its distributor failed to pay the ATESS Products according to the purchase price, ATESS is entitled to reject the claim under this warranty based on this provision.
- B. Cosmetic change in appearance stemming from the normal wear and tear over time of product materials, for example the out casing, charger sockets, charger plug, cables and so on
- C. Installation on mobile or in a marine environment, or extreme thermal environment, damage caused by ammonia, high air pollution, acid rain or any other abnormal environment that beyond ATESS's control;
- D. Misuse, abuse, neglect or accident, alteration, improper installation or application, Improper or unauthorized repair or modifications, power failure surges, lightning, flood, fire, accidental breakage or other events outside ATESS's control.
- E. Service or installation by unapproved technicians who are not qualified under the relevant law or made illegible regulations at the place of installation.
- F. Installation by none approved company or person
- G. ATESS Products for which the nameplates or serial number have been altered, removed or made illegible.
- H. ATESS Products which have been moved from their original installation location without the express written approval of ATESS.
- I. Defective components in the construction on which the ATESS Products are mounted.
- J. Wi-Fi connectivity, internet connectivity or APP connectivity is not covered or any associated connectivity issues

Warranty

Dual Wall Pro Earth



4. General Conditions for Warranty Claims

A. The direct customers who have obtained the ATESS Products shall register the ATESS Products and upload the information within 30 days from the date of receiving the ATESS Products. If the customers fail to register the product before the deadline, the Limited Product Warranty will remain at 3 years. The warranty registration can be done either through the APP or via the website.

B. The direct customer shall notify the warranty claims to Authorized 5 Year Warranty Installer or its Distributor within 1 week via email only after becoming aware of the circumstances which constitute a warranty case. The report shall include the following information:

1. Name and address of the END CUSTOMER
2. Name and address of the INSTALLER or SELLER
3. A copy of the purchase agreement or installation agreement

4. Module type and serial number of the respective ATESS Products

5. Address of the place of installation of the respective ATESS Products

6. A short description of the problem at hand as well as a short description of the tests which may have already been performed as well as their results.

7. Regarding any defect or fault, where possible, pictures and videos of the effected ATESS products clearly showing the problem or fault.

C. Any repaired or replaced ATESS Products provided by ATESS under a warranty claim, shall be covered by the same Limited Warranty and terms as the first ATESS Products purchased.

D. No warranty periods or terms shall be extended because of a warranty claim or remedy.

E. The Limited Warranty does not cover any transportation costs for return of the defective ATESS Products or for reshipment of any repaired or replaced ATESS Products or costs associated with installation, removal or re-installation of repaired, replacement or additional ATESS Products.

F. The Limited Warranty does not cover any other costs, loss of use, loss of profits, and loss of production, loss of revenues associated with performance or non-performance of defective ATESS Products.

G. If the authorized partner should cease to trade the warranty reverts to ATESS standard UK warranty which can be viewed online at www.atesspower.com. The warranty is only valid through a valid Authorized 5 Year Warranty Installer directly. ATESS will not cover any product unless it goes through an Authorized 5 Year Warranty Installer. ATESS Warranty is with and for the Authorized 5 Year warranty installer. This product is covered by authorized partner.

H. 5 Year Warranty only applies to products installed by an Authorized 5 Year Warranty Installer.

I. An upgrade may be offered at an additional cost should the product or the components be unavailable at an additional cost.

J. Refurbished or factory reconditioned products may be used in part exchange.

K. No responsibility will be taken by ATESS for fluctuations in voltage supplied from the National Grid that may affect performance and may cause the EV charger to fail or fault.

L. An approved installation or technical partner must be used, none approved third party invalidate this warranty in full.

M. A call out costs and labor charges will be applicable in all cases.

N. The EV charger must be accessible by ATESS and the consumer to read any faults.

O. The EV charger must be online and have latest firmware, and make sure the authorized installer can diagnosis potential faults and settings remotely or further labor costs will be required.

P. The units must be connected so remote analysis can be confirmed or further charges may be required

Q. Replacement product for warranty claims can only be honored through an Authorized 5 Year Warranty Installer; in this case ATESS has the right to terminate claims over and above its standard terms and conditions if claims do not come through Authorized 5 Year Warranty Installer Ltd.

Warranty

Dual Wall Pro Earth

5. Dispute regarding a material defect or a reduced power

In case of a dispute regarding the existence of a material defect or reduced power in a warranty claim, ATESS will accept the judgment of an accredited testing institute (which is to be selected by ATESS in advance.) The cost and expenses for the testing shall remain with the Buyer if it is found to be good performance.

6. Force Majeure

ATESS shall not be responsible or liable in any way to the Buyer for any non-performance or delay in performance under this Limited Warranty due to occurrences of force majeure such as, war, riots, strikes, epidemic, unavailability of suitable and sufficient labor, material, or capacity or technical or yield failures and any unforeseen event beyond its control, including, without limitation, any technological or physical event or condition which is not reasonably known or understood at the time of the sale of the defective Product(s) or the notification of the relevant warranty claim under this Limited Warranty.

7. Validity

This Limited Warranty shall apply to ATESS Products (s) manufactured after 1st of Jan 2020. This Limited Warranty shall be valid until a new revision is issued by ATESS and is subject to change without prior notice.

8. Others

EV charger spare parts and service costs are assessed each year, subject to the latest prices. ATESS reserves the right to interpret other unmentioned matters.

What Affects The Charging Time Of An Electric Vehicle?

In the case of AC charging the time required to charge depends on the power of the charger, as well as the power of the inverter installed within the vehicle.

What Kind Of Electrical Connection Is Required To Supply A Charging Station?

The power of the connection depends on the power of the charger. In the case of AC charging station, it is between 3.7kW and 22kW.

What are the benefits of Electric Vehicles (EV)?

Reduced Emissions – Electric vehicles produce fewer greenhouse gas emissions than internal combustion engines.

Improved Air Quality – Fewer emissions means reduced environmental pollutants and improved air quality.

Cost Savings

- Fuel – Electricity costs are typically less costly than gasoline.
- Maintenance – Electric vehicles, including plug-in hybrid have fewer powertrain components and have fewer maintenance requirements than internal combustion engines, i.e. oil changes, brakes, etc.
- Reduced Noise – Electric vehicles are typically quieter and reduce engine noise dramatically.

What is the difference between a Level 2 charger and a DC fast charger?

Project EV (240 volt AC input) Pedestal and Wall Mount EV charging stations are well-suited for any commercial or public location. The sleek design and product features are perfect for spaces such as: retail locations, restaurants, hotels, public parking areas, schools, apartments, office buildings, or airports.

Project EV, DC Fast Chargers deliver the fastest EV charging rate currently available. The DC Fast Charger is perfect for high-traffic commercial locations, fleets installations, gas stations, and at locations along major transportation corridors. The DC Fast Charger is classified as a DC, 750volt, 50amp 3-Phase AC input charging station capable of 37.5 kW charge per hour.

My Project EV charger is not working and there are no lights on the unit

Check that the circuit breaker at the consumer unit is in the on position. If problem persists, contact Project EV.

My Project EV charger is not working and is continually flashing red

The unit has detected an overvoltage and has shut down for safety purposes. Turn off the charger for around a minute and turn back on. If problem persists, contact Project EV.

My Project EV charger is not working and is continually flashing red two times

The unit has detected an undervoltage and has shut down for safety purposes. Turn off the charger for around a minute and turn back on. If problem persists, contact Project EV.

My Project EV charger is not working and is continually flashing red three times

Check that the red emergency stop button at the top right-hand side of the charger hasn't been accidentally pressed. Turn the button slightly right to release. If problem persists, contact Project EV.

My Project EV charger is not working and is continually flashing red four times

The unit has detected an overcurrent. Please turn off the charger at the consumer unit for around a minute and turn back on. If problem persists, contact Project EV.

My Project EV charger is not working and is continually flashing red five times

Overtemperature has been detected. Please turn off your charger at the consumer unit and leave for a short time before turning back on. If problem persists, contact Project EV.

My Project EV charger is not working and is continually flashing red six times

Reset the RCD switch on the left-hand side of the charger. Please note: The small reset button next to the RCD switch will need to be pushed for the switch to stay in the on position. If problem persists, contact Project EV.

My Project EV charger is not working and is continually flashing red fourteen times

The anti-tamper switch on the charger has been activated, the cover is either loose or has been removed, check, and replace as necessary. If the problem persists, contact Project EV.

My Project EV app is showing my charger as "Unavailable"

Please check your home WiFi and ensure that it is working properly. Is the distance between the charger and home router 10m or more? A WiFi extender may be required to boost the range of WiFi in your property. Check your signal strength by standing next to your charger and scanning for your home WiFi using a mobile phone or tablet. Please check our YouTube channel to watch our tutorials, support site or contact the Project EV team directly.

My Project EV app is showing my charger as "Preparing"

Press "Start" on the app.

My Project EV app is showing "Door open"

The anti-tamper has been activated, the cover is either loose or has been removed, check and replace as necessary. If the problem persists, contact Project EV.

My Project EV charger is not working and is showing an Amber light

Press "Start" on the app.

My Project EV charger is not working and is pulsing Green

Vehicle is fully charged.

I cannot get my charger connected to my home WiFi via the app

This process should be done by the installer during installation as this helps validate your warranty. However, if for any reason the internet drops out, please check our YouTube channel to watch our tutorial, support site or contact the Project EV team directly.

I need help setting Reserved Charging in order to take advantage of off-peak energy tariff

Please check our YouTube channel to watch our tutorials, support site or contact the Project EV team directly.



@projectevuk



@weareprojectev



@projectev

FOLLOW US ON SOCIAL MEDIA

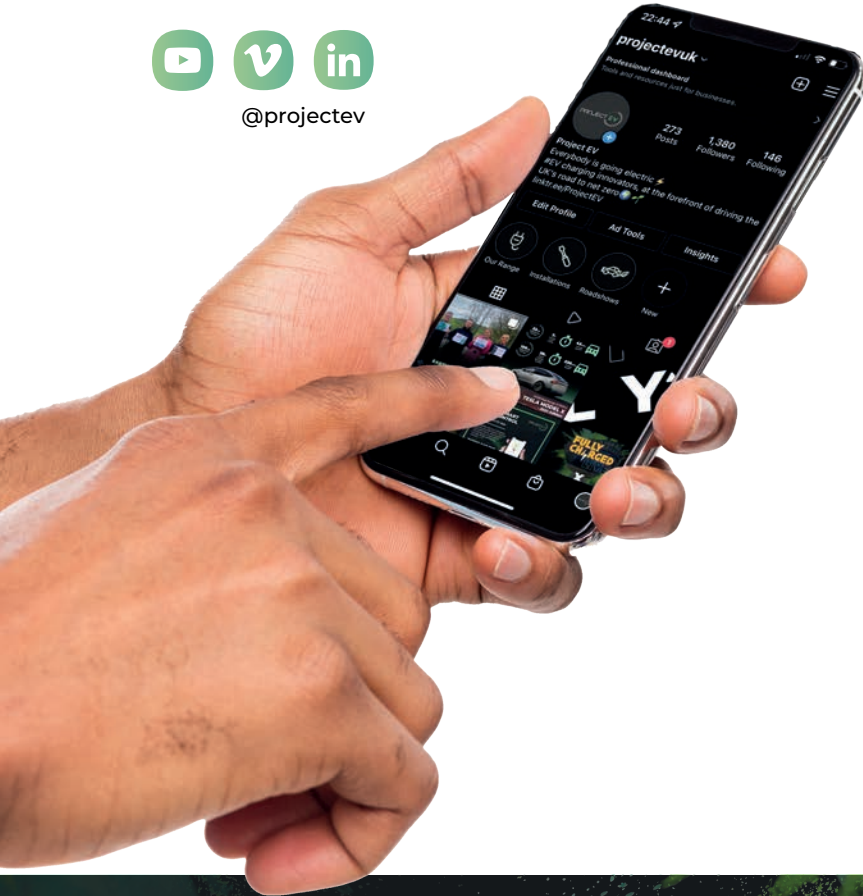

THE FUTURE OF EV CHARGING



EVA-07D-SE-W / EVA-22D-SE-W
EVA-07D-SE-W-C / EVA-22D-SE-W-C

Project EV,
Unit 1 Lakes Court,
Lancaster Park,
Newborough Road,
Burton-On-Trent
DE13 9PD

www.projectev.co.uk

enquiries@projectev.co.uk
0800 599 9582